



USER GUIDE



Cisco Unified Communications Manager Express User Guide for Cisco Unified IP Phone 7975G

- 1 Overview
- 2 Operating Your Phone
- 3 Phone Features Index

1 Overview











This guide provides operating instructions, and feature descriptions for the Cisco Unified IP Phone multiline model 7975G. The Cisco Unified IP Phone 7975G is a touch screen phone.













Physical Description

Your Cisco Unified IP Phone 7975G provides touch-screen access, in addition to soft keys and dedicated buttons, allowing you to place and receive phone calls, put calls on hold, transfer calls, make conference calls, and so on.



86666

Name	Description
<p>1 Programmable or Line buttons</p> 	<p>Depending on the configuration, programmable buttons provide access to:</p> <ul style="list-style-type: none"> • Phone lines and intercom lines (line buttons) • Speed-dial numbers (speed-dial buttons, including the BLF speed-dial feature) • Web-based services (for example, a Personal Address Book button) • Call features (for example, a Privacy, Hold, or Transfer button) Buttons light to indicate status: <p>Buttons light to indicate status:</p> <ul style="list-style-type: none">  Green, steady: Active call or two-way intercom call  Green, flashing: Held call  Amber, steady: Privacy in use, one-way intercom call, DnD active, or logged into Hunt Group  Amber, flashing: Incoming call or reverting call  Red, steady: Remote line in use (shared line or BLF status)
<p>2 Footstand adjustment</p>	<p>Allows you to adjust phone base angle.</p>
<p>3 Display button</p> 	<p>Awakens the touch screen from sleep mode or disables it for cleaning.</p> <ul style="list-style-type: none">  No color: Ready for input  Green flashing: Disabled  Green steady: Sleep mode
<p>4 Messages button</p> 	<p>Auto-dials your voice message service.</p>

	Name (continued)	Description (continued)
5	Directories button 	Provides access to phone directories.
6	Help button 	Activates Help menu. (Currently not supported)
7	Settings button 	Provides access to phone settings to change touch screen and ring settings.
8	Services button 	Provides access to phone services.
9	Volume button 	Increases or decreases handset, headset, ringer, or speakerphone volume.
10	Speaker button 	Toggles speaker on and off.
11	Mute button 	Toggles mute on and off.
12	Headset button 	Toggles headset on and off.
13	4-way Navigation Pad and Select (center) button 	<p>Allows you to scroll through menus and highlight items, displays phone numbers from your Placed Calls, when phone is on-hook. Use Select button to select an item that is highlighted on the screen.</p> <p>Navigation button</p> <ul style="list-style-type: none"> • Scroll up and down to see menus and highlight items. • Scroll left to open the Details view and see directory numbers and features assigned to each line button (when on call screen). • Scroll right to close the Details view. <p>Select button—scroll to select a line using the Navigation button, then:</p> <ul style="list-style-type: none"> • If the button is mapped to a directory number, and: <ul style="list-style-type: none"> – The line is idle, press  to initiate a new call. – There is an on-hold call on the line, press  to resume the call. – There is an active call on the line, the Select button has no effect. • If the button is mapped to a feature, press  to access the feature.
14	Keypad	Functions like a traditional telephone keypad.
15	Soft keys buttons	Engages the functions displayed on the corresponding LCD tabs.
16	Handset with indicator light	Functions like a traditional handset and provides message waiting indicator light and message-waiting (stutter) tone.
17	Touchscreen	Shows phone's touch screen features.

Connecting Your Phone

This section shows and describes the connectors on your Cisco Unified IP phone.

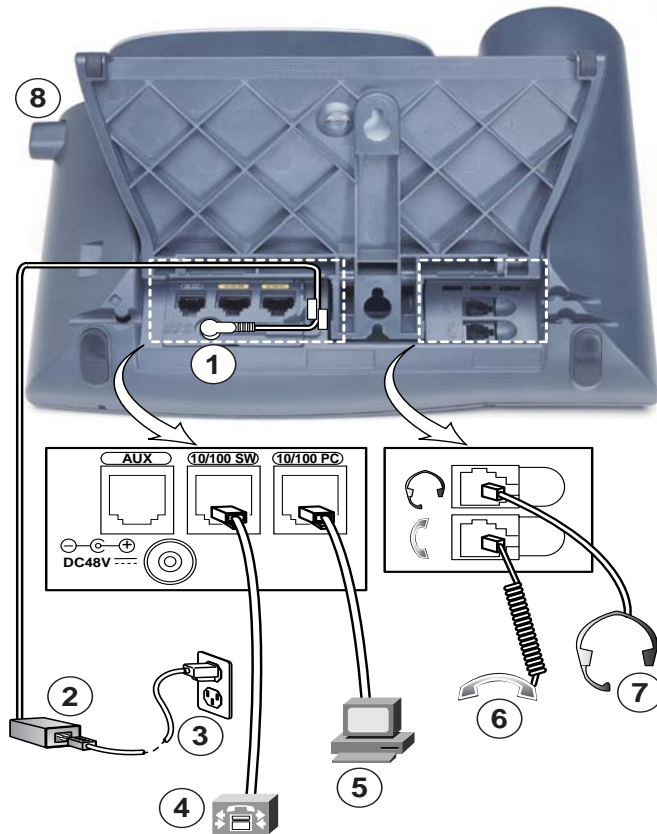

113656

1	DC adapter port (DC48V) for phones not provided with inline power
2	AC-to-DC power supply
3	AC power cord
4	Network port (10/100 SW) for connecting to the network
5	Access port (10/100 PC) for connecting your phone to your computer
6	Handset port
7	Headset port
8	Footstand button

Adjusting the Handset Rest

When you connect your phone, you can adjust the handset rest so that the receiver will not slip out of the cradle. To adjust the handset:

1. Set the handset aside and pull the square plastic tab from the handset rest.
2. Rotate the tab halfway.
3. Slide the tab back into the handset rest. An extension protrudes from the top of the rotated tab.
4. Return the handset to the handset rest.

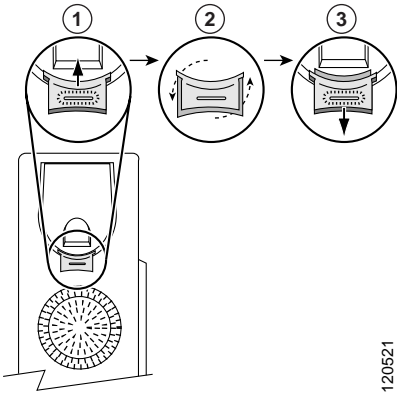

120521

Touch Screen Features

This is what your main touch screen might look like with active calls and several feature menus open.



120781

1	Primary phone line	Displays the phone number (directory number) for your primary phone line.
2	Programmable button indicators	Programmable buttons  can serve as phone line buttons, speed-dial buttons, phone service buttons or phone feature buttons. Icons and labels indicate how these buttons are configured.
3	Soft key labels	Each displays a soft key function. Soft key labels are touch-sensitive.
4	Status line	Displays audio mode icons, status information, and prompts.
5	Call activity area	Displays current calls per line, including caller ID, call duration, and call state for the highlighted line (standard view). Items in this area are touch-sensitive.
6	Phone tab	Indicates call activity. Press this tab to return to the call activity area, if needed.
7	Feature tabs	Each indicates an open feature menu. Tabs are touch-sensitive.



Choosing Touch Screen Items

To choose items on your phone's touch screen, use one of the following methods:

- By touch, press (or tap) touch-sensitive items on the touch screen with your fingertip. Use only your fingertip to press the touch screen because using any other objects could damage the display. Be aware that pressing a phone number can cause the phone to dial the number.
- By item number, press the corresponding number on your keypad. For example, press **4** to choose the fourth item in a menu.

- By scrolling, press the Navigation button to highlight an item. Press a soft key to finish the action, or tap the item on the touch screen with your fingertip.

Cleaning and Maintaining the Touch Screen

To disable the touch screen for cleaning, press  and hold for more than one second.  flashes. The screen remains disabled for about a minute, unless you enable it.

To enable the touch screen (after disabling it), press  (flashing) and hold for more than one second.

To wake the touch screen from sleep mode, press the touch screen or any button, or lift the handset. After a period of inactivity (determined by your system administrator), the touch screen enters sleep mode to save power. In this mode, the touch screen appears blank and  remains lit.







Caution

Use only a soft, dry cloth to wipe the touch screen. Do not use any liquids or powders on the phone, because they can contaminate phone components and cause failures.

Feature Buttons and Menus

To open or close a feature menu, press a feature button:

-  Messages
-  Services
-  Help
-  Directories
-  Settings

To scroll through a list or menu, press the Navigation button.

To go back one level in a feature menu, press **Exit**. Pressing Exit from the top level of a menu closes the menu.







To switch between open feature menus, press a feature tab on your touch screen. Each feature menu has a corresponding tab. The tab is visible when the feature menu is open.





Line and Call Icons

The difference between lines and calls is as follows:

- Lines: Each corresponds to a directory number that others can use to call you. Your phone can support up to eight lines. To see your phone lines, look at the right side of your touch screen. You have as many lines as you have directory numbers and phone line icons: .
- Calls: Each line can support two calls. Only one call can be active at any time; other calls are automatically placed on hold.

Your phone displays icons to indicate the line and call state.

Icon	Line or call state	Description
	On-hook line	No call activity on this line.
	Off-hook line	You are dialing a number or an outgoing call is ringing.
	Connected call	You are connected to the other party.
	Ringing call	A call is ringing on one of your lines.
	Call on hold	You have put the call on hold.
	Remote-in-use	Another phone that shares your line has a connected call.

Icon	Line or call state	Description
	Authenticated call	Verifies the identities of all phones participating in a call.
	Encrypted call	Identifies phones receiving encrypted call (your audio) within the Cisco unified IP Network.
	Idle line (BLF)	Indicates the line is idle, when using Busy Lamp Feature (BLF).
	Busy line (BLF)	Indicates the line is busy, when using Busy Lamp Feature (BLF).

2 Operating Your Phone

This section describes how to operate your Cisco Unified IP phone and includes information on soft keys and phone features.



Note Because there are differences in phone and site configuration, not all features described here may apply to your phone. Consult system administrator for more information.

Soft Key Descriptions

Your Cisco Unified IP phone is equipped with soft keys for call features and options. Soft keys are listed along the bottom of the LCD screen and activated using the corresponding buttons. Soft keys can change according to the state of the phone.

Following is a comprehensive list of soft keys offered on the Cisco Unified IP Phone 7975G. Functions depends on your system configuration.

Soft Key	Function
<<or >>	Navigates to edit characters. Use the backspace soft key to erase digits that you entered incorrectly.
Acct	Account Code, consult your administrator on the use of this soft key.
Answer	Answers incoming call.
Callback	Notifies callers that called line is free.
Cancel	Cancels last selection.
CFwdALL	Forwards all calls.
Clear	Clears directory history.
Confrn	Connects callers to conference call.
Delete	Deletes selected number.
Dial	Dials displayed number.
DnD	Enables Do-Not-Disturb feature.
Down	Decreases LCD screen contrast.
EditDial	Selects number and activates cursor for editing.
EndCall	Ends current call.
Exit	Exits from current selection.
Flash	Provides hookflash functionality for three-way calling and call waiting services provided by the PSTN or Centrex service.
GPickUp	Selectively pick up calls coming into a phone number that is member of pickup group.
Hold	Places active call on hold. Resumes on hold call.

Soft Key	Function
Login	Provides PIN-controlled access to restricted phone features. Contact your local administrator for additional instructions.
MeetMe	Starts a new MeetMe Conferences
more	Scrolls through additional soft key options (for example, use the more soft key to locate the DnD soft key).
NewCall	Opens new line on speakerphone to place call.
Ok	Confirms selection.
Park	Forwards calls to location from which call can be retrieved by anyone in the system.
PickUp	Selectively picks up calls coming into another extension.
Play	Plays ring sound samples.
Redial	Redials last number dialed.
Remove	Removes conference participant
RmLstC	Removes Last Participant from the Conference Call.
Resume	Returns to active call.
Save	Saves last change.
Search	Initiates search in local directory.
Select	Selects highlighted option.
Trnsfer	Transfers active calls to another extension.
Up	Increases LCD screen contrast.
Update	Updates content.

Phone Features





This section provides information on using your phone's features and includes:

- Basic—Place a Call 9
- Additional Options—Place a Call 10
- Answer a Call 10
- End a Call 10
- Hold and Resume a Call 10
- Mute a Call 10
- Manage Call Waiting 11
- Retrieve Voice Messages 11
- Adjust the Volume for the Current Call 11
- Adjust the Ring Volume 11
- Select the Ring Type 11
- Adjust the Display Contrast 11
- Divert Incoming Calls 12
- Park a Call 12
- Call-Blocking (Toll Bar) Override 12
- View Multiple Calls 12
- Transfer a Call 13
- Forward All Calls 13

- Pick Up Calls 14
- Place and Establish Conference Call 14
- Place MeetMe Conference Call 14
- End a Conference Call 14
- Place Call from Your Local Directory 15
- Program Personal Speed-Dial Buttons 15
- Place a Call from Your System Speed-Dial Directory 15
- View Call History 15
- Place a Call from Call History 16
- Clear Call History 16
- Use the Intercom Feature 16
- Activate Do Not Disturb (DnD) 16

Basic—Place a Call

Use one of the following methods to place a call:

- Lift the handset and dial the number.
- Dial the number, and then lift the handset.
- Dial the number, and then press the **Dial** soft key.
- Press the **line** button for your extension, and then dial.
- Press the **Speaker** button, and then dial.
- Press the **New Call** soft key, and then dial.
- If you are using a headset, press the **Headset** button, and then dial. Or, if  is lit, press **New Call** and enter a number.
- Dial the number, and then press the **Headset** button.
- If you have selected a number from a directory, press the **Dial** soft key.
- Press **Redial** to dial the last number, or press the Navigation button (with the phone idle) to see your Placed Calls.
- If you are placing a call while another call is active (using the same line), press **Hold**, and then press **New Call** and enter the number?
- If you are dialing from the directory, choose  **Missed Calls**, **Received Calls**, or **Placed Calls**. Press the listings on the touch screen.
- If you are dialing on-hook, without a dial tone (predial), enter a number, then go off-hook by lifting the handset, pressing the number on the touch screen, or pressing **Dial**, , or .
- When you predial, your phone tries to anticipate the number you are dialing by displaying matching numbers (if available) from your **Placed Calls** log. This is called Auto Dial. To call a number displayed with Auto Dial, press the number, or scroll to it and go off-hook.



Note Use the backspace (<<) soft key to erase digits that you enter incorrectly.

Additional Options—Place a Call

To place a call while another call is active (using a different line):

1. Press  for a new line. The first call is automatically placed on hold.
2. Enter a number.







To dial from a Personal Address Book (PAB) entry:

1. Press  > **Personal Directory** to log in.

2. Choose **Personal Address Book** and search for a listing.



Answer a Call

Use one of the following methods to answer a call:

- Press  to answer with a headset, if unlit. Or, if  is lit, press **Answer** or  (flashing).
- Press  to answer with the speakerphone, press **Answer**, or  (flashing).
- Press **Answer** to switch from a connected call to answer a new call, or, if the call is ringing on a different line, press  (flashing).
- Press **Answer** to answer a call using call waiting.
- Press **iDivert** to send a call to your voice messaging system.

End a Call

Use one of the following methods to end a call:

- Hang up the handset or press **EndCall**.
- If you are using a headset, press . Or, to keep headset mode active, press **EndCall**.
- If you are using the speakerphone, press  or **EndCall**.
- Press **EndCall** to hang up one call, and preserve another call on the same line. If necessary, remove the call from hold first.

Hold and Resume a Call

Engaging the Hold feature typically generates music or a beep. A call-on-hold is indicated by the  icon.

To put a call on hold:

1. Make sure the call you want to put on hold is highlighted.
2. Press **Hold**.

To remove a call from hold on the current line, use the following method:

1. Make sure the appropriate call is highlighted.
2. Press **Resume**.

To remove a call from hold on a different line, press  (flashing) for the appropriate line. If a single call is holding on this line, the call automatically resumes. If multiple calls are holding, scroll to the appropriate call and press **Resume**.

Mute a Call

With Mute enabled, you can hear other parties on a call and they cannot hear you. You can use Mute in conjunction with the handset, speakerphone, or a headset.

Press  to toggle Mute on.

Press  to toggle Mute off.

Manage Call Waiting

If you are on a call when a second call comes in, you will hear a call-waiting tone or see a flashing indicator light on the handset rest, depending on the configuration of your phone.

To answer the new call on the same line:

1. Use the **Navigation** button to select the call
2. Press the **Answer** soft key to answer the call. The call on the other line will automatically be put on hold.

To return to the original call:

1. Use the **Navigation** button to reselect the call.
2. Press the **Resume** soft key to reconnect to the call.

For calls on a separate line:

- Press the **Line** button for the incoming call. The call on the other line will automatically be put on hold.

To return to the original call:

- Press the **Line** button associated with the original call.

Retrieve Voice Messages

To retrieve voice messages:

1. Select an available Cisco Unified IP phone line by lifting the handset, pressing the speakerphone button, or pressing a line button. Listen for the dial tone.
2. Press the **Messages** button, and follow the voice instructions.



Note When you have one or more new messages, the message-waiting indicator (MWI) light on your handset is lit. The MWI works only if you have the MWI configured on your phone.



Note Your company determines the voice message service that your phone system uses. For the most accurate and detailed information, refer to the documentation that came with your voice message service.

Adjust the Volume for the Current Call

To adjust the handset, speakerphone, or headset volume for the current call:

1. During a call, press the **Up** or **Down Volume** button.
2. Press the **Save** soft key to apply the new volume level to future calls.

Adjust the Ring Volume

- Press the **Up** or **Down Volume** button while the handset is in its cradle.

Select the Ring Type

To change the ringer sound:

1. Press the **Settings** button.
2. Press **2** for Ring Type, or use the **Navigation** button to scroll to Ring Type and press the **Select** soft key.
3. Use the **Navigation** button to scroll through the list of ring types. Press the **Play** soft key to hear samples.
4. Highlight the ring you want, and then press the **Select** soft key.
5. Press the **Ok** soft key to select your setting.
6. Press the **Save** soft key to save the setting, or press **Cancel** to exit to the previous menu without changing the setting.
7. Press the **Exit** soft key to return to the main directory menu.

Adjust the Display Contrast

To adjust the contrast in your LCD Display, perform the following steps:

1. Press the **Settings** button.
2. Press **1** for Contrast, or use the **Select** soft key.
3. Use the **Down** or **Up** soft key to change the contrast.
4. Press the **Ok** soft key.
5. Press the **Save or Exit** soft key.
6. Press the **Ok** soft key to select your contrast setting.

7. Press the **Save** soft key to save the setting, or press **Cancel** to exit to the previous menu without changing the setting.
8. Press the **Exit** soft key to return to the main directory menu.

 **Note** In the following procedures, you may be required to enter information using the keypad. Press the backspace (<<) soft key to erase digits that were entered incorrectly.

Divert Incoming Calls

To forward any incoming call to the call-forward destination set on the Cisco Unified IP phone:

- Press the **DnD** soft key.

 **Note** If the call-forward destination is not set, pressing the **DnD** soft key disables the ringer.

Park a Call

Call park allows a phone user to place a call on hold at a designated parking spot from which the call can be retrieved by anyone on the system. To park a call:

- Press the **Park** soft key

The Cisco Unified Communications Manager Express system will automatically select an available call part slot and displays the number on the Cisco Unified IP phone screen.

To park a call to a specific call park slot:

- Press the transfer button followed by the call part slot number provided by your local administrator.

To retrieve a parked call, use one of the following methods:

- If your phone receives a call park notification, press the **PickUp** soft key followed by the asterisk (*).
- Press the **PickUp** soft key followed by the call park slot number.

 **Note** Contact your administrator for your call park slot number.

Call-Blocking (Toll Bar) Override

Call blocking prevents unauthorized use of phones. It is implemented by matching a pattern of specified digits during a specified time of day and day of week or date. The call-blocking override feature allows individual phone users to override the call blocking that has been defined.

 **Note** Contact your administrator for your personal identification number (PIN).

To place calls when call-blocking is enabled, perform the following steps:

1. Press the **Login** soft key on the Cisco Unified IP phone.
2. Enter the PIN that is associated with the phone.

View Multiple Calls

In standard viewing mode, your phone displays calls as follows for the highlighted line:

- Calls with the highest precedence and longest duration display at the top of the list.
- Calls of a similar type are grouped together. For example, calls that you have interacted with are grouped near the top, and calls on hold are grouped last.

To view calls on another line, use the following method:

1. Press  .

2. Immediately press the line button  .

To switch to call overview mode, press  for the highlighted line. The phone switches to call overview mode, displaying only one call per line. The displayed call is either the active call or the held call with the longest duration.

To return to standard viewing mode, press  , then immediately press the line button.

Transfer a Call

To transfer a selected call to another number, you can use blind transfer or consultative transfer:

Blind Transfer

Immediately redirects the call without allowing you to speak to the transfer recipient (the person to whom you are transferring the call).

To make a blind transfer call, use the following method:

1. During a call, press the **Transfer** soft key. The call is placed on hold.
2. Dial the number to which you want to transfer the call.

Consultative Transfer

Redirects the call after first allowing you to speak to the transfer recipient.

To make a consultative transfer, use the following method:

1. During a call, press the **Transfer** soft key. The call is placed on hold.
2. Dial the number to which you want to transfer the call.
3. Wait for the call to be answered. Speak to the transfer recipient. Then press the **Transfer** button or hang up the handset.
4. If the transfer fails, press the **Resume** soft key to return to the original call.

Cancel Transfer

1. To cancel your consult call-transfer attempt:
 - Press the **EndCall** soft key.
2. To reconnect to the original caller:
 - Press the **Resume** soft key.

Forward All Calls

To forward all incoming calls to another number, perform the following steps:

1. Press the **CFwdALL** soft key. You will hear a confirmation beep.
2. Dial the number to which you want to forward all your calls. Dial the number exactly as you would if you were placing a call to that number. Remember to include locally required prefix numbers.
The phone display is updated to show that calls are to be forwarded.
3. Press the pound key (#) or the **EndCall** soft key.



Note To forward calls to voice mail, manually enter the voice-mail number, or use the soft key and button sequence of **CFwdALL** soft key plus the **Messages** button, followed by the **EndCall** soft key.

To forward calls to a speed-dial number, use the soft key and button sequence of the **CFwdALL** soft key plus a **speed-dial** button, followed by the **EndCall** soft key.

To cancel call forwarding, use one of the following methods:

- Press the **CFwdALL** soft key.

Pick Up Calls

To pick up a call that is on hold or a call that is ringing at another extension:

1. Press the **PickUp** soft key.
2. Dial the extension number of the Cisco Unified IP phone that you want to pick up. Control of the call is transferred to your phone.

To selectively pick up a call ringing at a number that belongs to a pickup group:

- Press the **GPickUp** soft key. If only one pickup group is defined in the entire Cisco Unified Communications Manager Express system, control of the call is transferred to your phone.
- If the ringing telephone and your phone are in the same pickup group, press the asterisk (*) to transfer control of the call to your phone.
- If the ringing telephone and your phone are in different pickup groups, dial the pickup group number where the phone is ringing to transfer control of the call to your phone.
- Press the **Other PickUp** or **OPickUp** soft key, if you want to pickup the call with the highest priority. This connects you to the call in the pickup group with the highest priority.

Place and Establish Conference Call

To place a conference call:

1. During a call, press the **more** soft key and then the **Confm** soft key to open a new line and put the first party on hold.
2. Place a call to another number.
3. When the call connects, press **Confm** again to add the new party to the call.

To establish a conference call between two- and three-party calls to a Cisco Unified IP phone, one active and the other on hold:

- Press the **Confm** soft key on the Cisco Unified IP phone.

To establish a conference call between two- and three-party calls already present on a Cisco Unified IP phone, using separate line buttons, one active and the other on hold:

1. Press the **Confm** soft key on the Cisco Unified IP phone.
2. Press the **Line** button of the call you want to add to the conference.



Note Your system administrator will have configured the system for three-party or eight-party ad-hoc conferences.

Place MeetMe Conference Call

To place a MeetMe conference call:

1. Obtain a MeetMe conference number from your administrator.
 2. Distribute the MeetMe conference number to all the participants.
 3. Go offhook, press the MeetMe softkey, and dial the MeetMe conference number. All other participants join the meeting by dialing into the MeetMe conference number.
- To end the MeetMe conference call, all participants must hang up the handset or press the **EndCall** soft key.

End a Conference Call

- To end the conference call:
1. Hang up the handset, or press the **EndCall** soft key.



Note Depending on configuration, when the conference call initiator disconnects, the conference call terminates.

Alternate Methods to End Conference Call

Call initiators may use one of the following methods (functionality will vary according to your system configuration):

- To disconnect from the conference, hang up the handset. The other parties remain on the conference call.

Place Call from Your Local Directory

To access the local phone directory established by the administrator:

1. Press the **Directories** button.
2. Press the Navigation **Up** or **Down** button or press **4** to select the Local Directory.
3. Press the Navigation **Up** or **Down** button to select the Last, First, or Number field search option.
4. Using the keypad, enter the last name or first name for the entry.

When entering letters, select the appropriate number key of the letter you want, and press that key a number of times that equals the position of the target letter. For example, to enter a B, press the 2 key two times, and to enter a C, press the 2 key three times. Use the backspace (<<) soft key to make corrections while entering data.

5. Press the **Search** soft key to find your selection.
6. If your search results in multiple listings, use the Navigation **Up** or **Down** button to select the correct number.
7. Press the **Dial** soft key to dial the selected number.

Program Personal Speed-Dial Buttons

After an administrator defines one or more speed-dial instances for a Cisco Unified IP phone, you can reprogram numbers that are not locked or program numbers into an instance that has an empty dial string:

1. Select an available phone line by lifting the handset, pressing the **NewCall** soft key, or pressing a line button. Listen for the dial tone.
2. Press the pound key (#).
3. Press the speed-dial button that you want to program. A short beep confirms that you are starting to program this button.
4. Enter the speed-dial number. The digits appear on the phone display. When you are entering speed-dial numbers on a Cisco Unified IP Phone, use the backspace (<<) soft key to erase digits that you entered incorrectly.

To remove a speed-dial number without replacing it with a new one:

1. Press the pound key (#).
2. Press the same speed-dial button a second time to indicate that you are done entering the speed-dial digits and to store the new speed-dial number.
3. Hang up the handset, or press a new speed-dial button and repeat this procedure.

Place a Call from Your System Speed-Dial Directory

To place a call from your system speed-dial directory:

1. Select an available Cisco Unified IP Phone line (off hook or **NewCall**) and get a dial tone.
2. **Press the Directories button**, or use the **Navigation** button to locate Directory and then press the **Select** soft key.
3. Use the **Navigation** button to scroll through the options. Use the **Select** soft key to select speed-dial options.
 - Press **5** for Local Speed Dial.
 - Press **6** for Personal Speed Dial (functionality varies depending on your system configuration).
4. Use the **Navigation** button to scroll through the speed-dial phone list.
5. To dial the selected phone number, either press the **Select** soft key or enter the number on the keypad.
6. Press the **Exit** soft key to go to the **Directory** menu.

View Call History

To view recent missed, received, or placed calls:

1. Press the **Directories** button.
2. Use the **Navigation** button to scroll and select the desired call list. Press the **Select** soft key, or
 - Press **1** on the keypad for Missed Calls.
 - Press **2** on the keypad for Received Calls.
 - Press **3** on the keypad for Placed Calls.
3. Press the **Exit** soft key to return to the previous directory menu.

Place a Call from Call History

To place a call to a number in the call history list:

1. Use the **Navigation** button to scroll through the call history list.
2. Use the **Select** soft key to select a phone number. The digits will appear on the phone display.
3. To dial the number as it appears on the phone display:
 - Press the **Dial** soft key.

To edit the number on the phone display before dialing:

1. Press the **EditDial** soft key to place the cursor at the beginning of the number on the phone display.
2. Use the keypad to edit the digits as needed. Use the backspace (<<) soft key to erase digits that you enter incorrectly.
3. Press the **Dial** soft key to place the call.

Clear Call History

To clear all numbers in the directory histories

- Press the **Clear** soft key.



Note The **Clear** soft key clears all call history lists. Selective clearing of call history lists is not supported.

Use the Intercom Feature

Cisco Unified Communications Manager Express supports intercom functionality for one-way and press-to-answer voice connections using a dedicated pair of intercoms on two phones that speed-dial each other.

To use the intercom feature:

1. Press the **Speaker** button and get the dial tone.
2. Press the speed dial key or dial the directory number to start the intercom call.



Note The called Cisco Unified IP phone automatically answers the call in speakerphone mode with mute activated or deactivated depending on configuration. The phone will beep to alert the recipient to the incoming call.

To respond to an intercom call:

- If Mute key is lighted, Press the **Mute** button, or lift the handset.
- If Mute key is not lighted, reply to caller handsfree.

Activate Do Not Disturb

For visual call alerting and information without audible ringing, use Do Not Disturb (DnD). Calls receive normal call-forward-busy and no-answer treatment.

To activate the Do-Not-Disturb feature:

1. Press the **more** soft key to locate the **DnD** soft key.
2. Press the **DnD** soft key. A display text message indicates that the phone is in Do-Not-Disturb mode.





Note Pressing the DnD soft key immediately forwards the call to the call-forward destination set on the phone. If the call-forward destination is not set, pressing the DnD soft key disables the ringer.



To deactivate the Do-Not-Disturb feature, repeat Steps 1 and 2.

Customizing the Touch Screen

To change the touch screen brightness:

1. Choose  > **User Preferences** > **Brightness**.
2. To make adjustments, press **Up**, **Down** or .
3. Press **Save**, or press **Cancel**.

To adjust the touch screen to accommodate your viewing angle:

1. Choose  > **User Preferences** > **Viewing Angle**.
2. To make adjustments, press **Up**, **Down** or .
3. Press **Save**, or press **Cancel**.

To change the background image:

1. Choose  > **User Preferences** > **Background Images**.
2. Scroll through available images and press **Select** to choose an image.
3. Press **Preview** to see a larger view of the background image.
4. Press **Exit** to return to the selection menu.
5. Press **Save** to accept the new image, or press **Cancel**.

To change the language on your touch screen:

1. Log in to your User Options web pages.
2. Access your user settings.

To change the line text label:

1. Log in to your User Options web pages.
2. Access your line label settings.

3 Phone Features Index

This section provides an alphabetical list of features for your Cisco Unified IP phone. Features supported in both SIP and SCCP protocols are marked as “Supported” and features not supported in either one of the protocols are marked as “Not Supported”. However, there are differences in how the feature works based on the call protocol.

Table 1 Features (with page number references) supported in SIP and SCCP protocols.

Phone Features	SIP	SCCP
Activate Do Not Disturb 16	Supported	Supported
Additional Options—Place a Call 10	Supported	Supported
Adjust the Display Contrast 11	Supported	Supported
Adjust the Ring Volume 11	Supported	Supported

Table 1 *Features (with page number references) supported in SIP and SCCP protocols.*

Phone Features	SIP	SCCP
Adjust the Volume for the Current Call 11	Supported	Supported
Answer a Call 10	Supported	Supported
Basic—Place a Call 9	Supported	Supported
Call-Blocking (Toll Bar) Override 12	Not Supported	Supported
Clear Call History 16	Supported	Supported
Divert Incoming Calls 12	Supported	Supported
End a Call 10	Supported	Supported
End a Conference Call 14	Supported	Supported
Forward All Calls 13	Supported	Supported
Hold and Resume a Call 10	Supported	Supported
Manage Call Waiting 11	Supported	Supported
Mute a Call 10	Supported	Supported
Park a Call 12	Not Supported	Supported
Pick Up Calls 14	Not Supported	Supported
Place a Call from Call History 16	Supported	Supported
Place a Call from Your System Speed-Dial Directory 15	Supported	Supported
Place and Establish Conference Call 14	Supported	Supported
Place Call from Your Local Directory 15	Supported	Supported
Place MeetMe Conference Call 14	Not Supported	Supported
Program Personal Speed-Dial Buttons 15	Not Supported	Supported
Retrieve Voice Messages 11	Supported	Supported
Select the Ring Type 11	Supported	Supported
Transfer a Call 13	Supported	Supported
Use the Intercom Feature 16	Supported	Supported
View Call History 15	Supported	Supported
View Multiple Calls 12	Supported	Supported



Americas Headquarters
Cisco Systems, Inc.
170 West Tasman Drive
San Jose, CA 95134-1706
USA

www.cisco.com
Tel: 408 526-4000
800 553-NETS (6387)
Fax: 408 527-0883

Asia Pacific Headquarters
Cisco Systems, Inc.
168 Robinson Road
#28-01 Capital Tower
Singapore 068912

www.cisco.com
Tel: +65 6317 7777
Fax: +65 6317 7799

Europe Headquarters
Cisco Systems International BV
Haarlerbergpark
Haarlerbergweg 13-19
1101 CH Amsterdam
The Netherlands

www-europe.cisco.com
Tel: 31 0 800 020 0791
Fax: 31 0 20 357 1100

Cisco has more than 200 offices worldwide. Addresses, phone numbers, and fax numbers are listed on the Cisco Website at www.cisco.com/go/offices.

CCVP, the Cisco logo, and the Cisco Square Bridge logo are trademarks of Cisco Systems, Inc.; Changing the Way We Work, Live, Play, and Learn is a service mark of Cisco Systems, Inc.; and Access Registrar, Aironet, BPX, Catalyst, CCDA, CCDP, CCIE, CCIP, CCNA, CCNP, CCSP, Cisco, the Cisco Certified Internetwork Expert logo, Cisco IOS, Cisco Press, Cisco Systems, Cisco Systems Capital, the Cisco Systems logo, Cisco Unity, Enterprise/Solver, EtherChannel, EtherFast, EtherSwitch, Fast Step, Follow Me Browsing, FormShare, GigaDrive, HomeLink, Internet Quotient, IOS, iPhone, IP/TV, IQ Expertise, the iQ logo, iQ Net Readiness Scorecard, iQuick Study, LightStream, Linksys, MeetingPlace, MGX, Networking Academy, Network Registrar, Packet, PIX, ProConnect, ScriptShare, SMARTnet, StackWise, The Fastest Way to Increase Your Internet Quotient, and TransPath are registered trademarks of Cisco Systems, Inc. and/or its affiliates in the United States and certain other countries.

All other trademarks mentioned in this document or Website are the property of their respective owners. The use of the word partner does not imply a partnership relationship between Cisco and any other company. (0705R)

© <2007> Cisco Systems, Inc. All rights reserved.

